

MAX®

HN120

HIGH PRESSURE CONCRETE TOOL

HOCHDRUCK-BETONWERKZEUG

OUTIL POUR BÉTON À HAUTE
PRESSIONPRESSION

ATTREZZO PER CALCESTRUZZO AD
ALTA PRESSIONE

HERRAMIENTA PARA HORMIGÓN DE
ALTA PRESIÓN

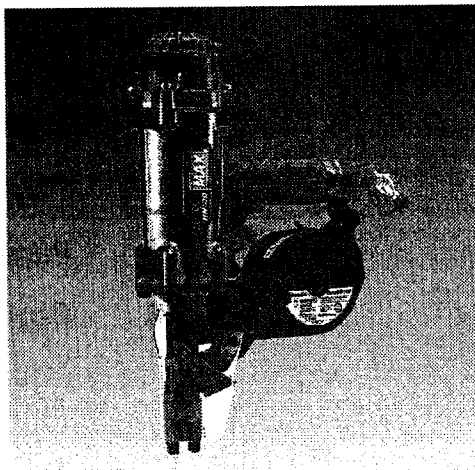

OPERATING and MAINTENANCE MANUAL
BETRIEBSANLEITUNG
MANUEL D'UTILISATION et D'ENTRETIEN
MANUALE DI FUNZIONAMENTO E MANUTENZIONE
MANUAL DE OPERACIONES Y MANTENIMIENTO

▲ WARNING:

BEFORE USING THIS TOOL, STUDY THIS MANUAL TO ENSURE SAFETY WARNING AND INSTRUCTIONS.
KEEP THESE INSTRUCTIONS WITH THE TOOL FOR FUTURE REFERENCE.

▲ ACHTUNG!

LESEN SIE VOR INBETRIEBNAHME DES GERÄTES DIE GEBRAUCHS- UND SICHERHEITSHINWEISE. BITTE BEWAHREN SIE DIE GEBRAUCHS- UND SICHERHEITSHINWEISE AUF, DAMIT SIE AUCH SPÄTER EINGESEHEN WERDEN KÖNNEN.

▲ AVERTISSEMENT:

AVANT D'UTILISER CET OUTIL, LIRE CE MANUEL ET LES CONSIGNES DE SECURITE AFIN DE GARANTIR UN FONCTIONNEMENT SUR.
CONSERVER CE MANUEL EN LIEU SUR AVEC L'OUTIL AFIN DE POUVOIR LE CONSULTER ULTERIEUREMENT.

▲ ATTENZIONE:

PRIMA DI USARE QUESTA MACCHINA, STUDIARE IL MANUALE PER PRENDERE ATTO DEGLI AVVERTIMENTI E DELLE ISTRUZIONI PER LA SICUREZZA.
TENERE QUESTE ISTRUZIONI INSIEME ALLO STRUMENTO PER CONSULTAZIONI FUTURE

▲ ATENCIÓN:

PARA EVITAR GRAVES DAÑOS PERSONALES O EN LA PROPIEDAD.
ANTES DE EMPLEAR LA HERRAMIENTA, LEER CON ATENCIÓN Y COMPRENDER LOS SIGUIENTES INSTRUCCIONES DE SEGURIDAD.

INDEX INHALTSVERZEICHNIS INDEX INDICE INDICE

| | |
|-----------------|---------------------------|
| ENGLISH | Page 3 to 16 Page |
| DEUTSCH | Page 17 to 30 Page |
| FRANÇAIS | Page 31 to 44 Page |
| ITALIANO | Page 45 to 58 Page |
| ESPAÑOL | Page 59 to 72 Page |

DEFINITIONS OF SIGNAL WORDS

| | |
|-----------------|---|
| WARNING: | Indicates a potentially hazardous situation which, if not avoided, could result in death or serious injury. |
| CAUTION: | Indicates a potentially hazardous situation which, if not avoided, may result in minor or moderate injury. |
| NOTE: | Emphasizes essential information. |

DEFINITIONEN DER HINWEISBEZEICHNUNGEN

| | |
|------------------|---|
| ACHTUNG! | Zeigt eine eventuell gefährliche Situation an, die den Tod oder schwere Verletzungen zur Folge haben könnte, wenn sie nicht vermieden wird. |
| VORSICHT! | Zeigt eine eventuell gefährliche Situation an, die leichte oder mittelschwere Verletzungen zur Folge haben könnte, wenn sie nicht vermieden wird. |
| HINWEIS: | Hebt wichtige Informationen hervor. |

DÉFINITIONS DES DIFFÉRENTS DEGRÉS D' AVERTISSEMENTS

| | |
|----------------------|--|
| AVERTISSEMENT | Indique une situation éventuellement dangereuse qui, si elle n'est pas contournée, pourrait provoquer la mort ou des blessures sérieuses. |
| ATTENTION | Indique une situation éventuellement dangereuse qui, si elle n'est pas contournée, pourrait provoquer des blessures légères à moyennement sérieuses. |
| REMARQUE | Souligne des informations importantes. |

DEFINIZIONE DELLE INDICAZIONI DI AVVERTIMENTO

| | |
|--------------------|--|
| ATTENZIONE: | Indica l'eventualità che possa verificarsi una situazione pericolosa, la quale se non viene evitata, può risultare letale o provocare gravi lesioni. |
| AVVERTENZA: | Indica l'eventualità che possa verificarsi una situazione pericolosa, la quale se non viene evitata, può provocare lesioni di lieve o media entità. |
| NOTA: | Evidenzia informazioni importanti. |

DEFINICIÓN DE LAS INDICACIONES DE ADVERTENCIA

| | |
|---------------------|---|
| ¡ATENCIÓN! | Indica una situación potencialmente peligrosa que podría causar la muerte o graves lesiones si no se evita. |
| ¡PRECAUCIÓN! | Indica una situación potencialmente peligrosa que podría causar lesiones menos graves o leves si no se evita. |
| NOTA: | Resalta informaciones importantes. |

ENGLISH

HN120

HIGH PRESSURE CONCRETE TOOL

INDEX

- 1. SAFETY INSTRUCTIONS4**
- 2. SPECIFICATIONS &
TECHNICAL DATA7**
- 3. AIR SUPPLY AND CONNECTIONS ...9**
- 4. INSTRUCTIONS FOR OPERATION ...10**
- 5. MAINTAIN FOR PERFORMANCE ...16**
- 6. STORING16**
- 7. TROUBLESHOOTING/REPAIRS.....16**

OPERATING and MAINTENANCE MANUAL

▲ WARNING:

BEFORE USING THIS TOOL. STUDY THIS MANUAL TO ENSURE SAFETY WARNING AND INSTRUCTIONS.

KEEP THESE INSTRUCTIONS WITH THE TOOL FOR FUTURE REFERENCE.

1. SAFETY INSTRUCTIONS



▲ WARNING:

TO AVOID SEVERE PERSONAL INJURY OR PROPERTY DAMAGE BEFORE USING THE TOOL, READ CAREFULLY AND UNDERSTAND THE FOLLOWING "SAFETY INSTRUCTIONS". FAILURE TO FOLLOW WARNINGS COULD RESULT IN DEATH OR SERIOUS INJURY.

PRECAUTIONS ON USING THE TOOL



1. WEAR SAFETY GLASSES OR GOGGLES

Danger to the eyes always exists due to the possibility of dust being blown up by the exhausted air or of a fastener flying up due to the improper handling of the tool. For these reasons, safety glasses or goggles shall always be worn when operating the tool.

The employer and/or user must ensure that proper eye protection is worn. Eye protection equipment must conform to the requirements of the American National Standards Institute, ANSI Z87.1 (Council Directive 89/686/EEC of 21 DEC. 1989) and provide both frontal and side protection.

The employer is responsible to enforce the use of eye protection equipment by the tool operator and all other personnel in the work area.

NOTE: Non-side shielded spectacles and face shields alone do not provide adequate protection.



2. EAR PROTECTION MAY BE REQUIRED IN SOME ENVIRONMENTS

As the working condition may include exposure to high noise levels which can lead to hearing damage, the employer and user should ensure that any necessary hearing protection is provided and used by the operator and others in the work area.



3. WHEN USING THE TOOL, BE SURE TO USE A SPECIAL AIR COMPRESSOR AND AIR HOSE

In order to improve its performance, it has set its working pressure higher than the conventional nailers. To use the tool, you always need the special air compressor and air hose (MAX PowerLite Compressor and MAX PowerLite Hose). Use of high-pressure gas (for example, oxygen, acetylene, etc.) causes abnormal combustion, possibly resulting in explosion. Use only the special air compressor and air hose.



4. OPERATE WITHIN THE PROPER AIR PRESSURE RANGE

The tool is designed to operate within an air pressure range of 210 to 320 p.s.i. (15 to 23 bar.)

The pressure should be adjusted to the type of the work being fastened. The tool shall never be operated when the operating pressure exceeds 320 p.s.i. (23 bar.)



5. DO NOT OPERATE THE TOOL NEAR A FLAMMABLE SUBSTANCE

Never operate the tool near a flammable substance (e.g., thinner, gasoline, etc.). Volatile fumes from these substances could be drawn into the compressor and compressed together with the air and this could result in an explosion.

6. DO NOT USE A WRONG FITTINGS

The connector on the tool must not hold pressure when air supply is disconnected. If a wrong fitting is used, the tool can remain charged with air after disconnecting and thus will be able to drive a fastener even after the air line is disconnected, possibly causing injury.



7. DISCONNECT THE AIR SUPPLY AND EMPTY THE MAGAZINE WHEN THE TOOL IS NOT IN USE

Always disconnect the air supply from the tool and empty the magazine when operation has been completed or suspended, when unattended, moving to a different work area, adjusting, disassembling, or repairing the tool, and when clearing a jammed fastener.



8. INSPECT SCREW TIGHTNESS

Loose or improperly installed screws or bolts cause accidents and tool damage when the tool is put into operation. Inspect to confirm that all screws and bolts are tight and properly installed prior to operating the tool.



9. DO NOT TOUCH THE TRIGGER UNLESS YOU INTEND TO DRIVE A FASTENER

Whenever the air supply is connected to the tool, never touch the trigger unless you intend to drive a fastener into the work. It is dangerous to walk around carrying the tool with the trigger pulled, and this and similar actions should be avoided.



10. NEVER POINT THE DISCHARGE OUTLET TOWARD YOURSELF AND OTHER PERSONNEL

If the discharge outlet is pointed toward people, serious accidents may be caused when misfiring. Be sure the discharge outlet is not pointed toward people when connecting and disconnecting the hose, loading and unloading the fasteners or similar operations.

11. USE SPECIFIED FASTENERS (SEE PAGE 7)

The use of fasteners other than specified fasteners will cause the tool malfunction. Be sure to use only specified fasteners when operating the tool.



12. PLACE THE DISCHARGE OUTLET ON THE WORK SURFACE PROPERLY

Failure to place the discharge outlet of the nose in a proper manner can result in a fastener flying up and is extremely dangerous.



13. KEEP HANDS AND BODY AWAY FROM THE DISCHARGE OUTLET

When loading and using the tool, never place a hand or any part of body in fastener discharge area of the tool. It is very dangerous to hit the hands or body by mistake.



14. DO NOT DRIVE FASTENERS CLOSE TO THE EDGE AND CORNER OF THE WORK AND THIN MATE RIAL

The workpiece is likely to split and the fastener could fly free and hit someone.



15. DO NOT DRIVE FASTENERS ON TOP OF OTHER FASTENERS

Driving fasteners on the top of other fasteners may cause deflection fasteners which could cause injury.

16. REMOVING THE FASTENERS AFTER COMPLETING OPERATION

If fasteners are left in the magazine after the completion of operation, there is the danger of a serious accident occurring prior to the resumption of operation, should the tool be handled carelessly, or when connecting the air fitting. For this reason, always remove all fasteners remaining in the magazine after completion of the operation.

17. CHECK OPERATION OF THE CONTACT TRIP MECHANISM FREQUENTLY IN CASE OF USING A CONTACT TRIP TYPE TOOL

Do not use the tool if the trip is not working correctly as accidental driving of a fastener may result. Do not interfere with the proper operation of the contact trip mechanism.

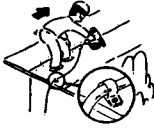

18. WHEN USING THE TOOL OUTSIDE OR ELEVATED PLACE

When fastening roofs or similar slanted surface, start fastening at the lower part and gradually work your way up. Fastening backward is dangerous as you may lose your foot place.

Secure the hose at a point close to the area you are going to drive fasteners. Accidents may be caused due to the hose being pulled inadvertently or getting caught.

19. NEVER USE THE TOOL IF ANY PORTION OF THE TOOL CONTROLS (e.g., TRIGGER, CONTACT ARM) IS INOPERABLE, DISCONNECTED, ALTERED OR NOT WORKING PROPERLY

20. NEVER ACTUATE THE TOOL INTO FREE SPACE

This will avoid any hazard caused by free flying fasteners and excessive strain of the tool.

21. ALWAYS ASSUME THAT THE TOOL CONTAINS FASTENERS

22. RESPECT THE TOOL AS A WORKING IMPLEMENT

23. NO HORSEPLAY

24. NEVER LOAD THE TOOL WITH FASTENERS WHEN ANY ONE OF THE OPERATING CONTROLS (e.g., TRIGGER, CONTACT ARM) IS ACTIVATED

**OBSERVE THE FOLLOWING GENERAL CAUTION IN ADDITION TO
THE OTHER WARNINGS CONTAINED IN THIS MANUAL**

- Do not use the tool as a hammer.
- Always carry the tool by the handle, never carry the tool by the air hose.
- The tool must be used only for the purpose it was designed.
- Never remove, tamper with the operating controls (e.g., TRIGGER, CONTACT ARM)
- Keep the tool in a dry place out of reach of children when not in use.
- Do not use the tool without Safety Warning label.
- Do not modify the tool from original design or function without approval by MAX CO., LTD.

2. SPECIFICATIONS AND TECHNICAL DATA

1. NAME OF PARTS

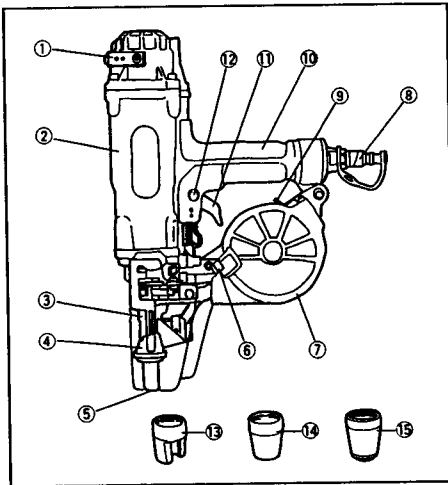

- ① Exhaust Cover
- ② Frame
- ③ Nose
- ④ Contact Arm
- ⑤ Discharge Outlet
- ⑥ Magazine Cap Lever
- ⑦ Magazine
- ⑧ Air Plug
- ⑨ Magazine Lock Lever
- ⑩ Grip
- ⑪ Trigger
- ⑫ Trigger Lock Dial
- ⑬ Attachment-A (Used for securing a thin steel plate to the concrete)
- ⑭ Attachment-B (Used for securing a wooden material to the concrete or a thick steel plate)
- ⑮ Attachment-C (Used for a light gage steel track to the concrete)

2. TOOL SPECIFICATIONS

| | |
|--------------------------------|---|
| PRODUCT NO. | HN120 |
| HEIGHT | 15-3/4" (400 mm) |
| WIDTH | 3-3/8" (85 mm) |
| LENGTH | 12-3/8" (315 mm) |
| WEIGHT | 6.4 lbs. (2.9 kg) |
| RECOMMENDED OPERATING PRESSURE | 210 to 320 p.s.i. (15 to 23 bar) |
| LOADING CAPACITY | 50 Nails |
| AIR CONSUMPTION | 4.7 ℓ at 322 p.s.i. (23 bar) operating pressure |

3. FASTENER SPECIFICATIONS

| NAIL LENGTH | PLASTIC SHEET COLLATED NAILS | PLASTIC SHEET COLLATED PINS |
|--------------------|------------------------------------|------------------------------------|
| | 1-1/4" to 2-1/2" (32 to 65 mm) | 7/8" to 2" (22 to 52 mm) |
| SHANK DIAMETER | .113" to .148" (φ 2.9 to φ 3.8 mm) | .148" (φ 3.8 mm) |
| SHANK TYPE | Smooth, Screw | Smooth |
| HEAD DIAMETER | .256" to .303" (φ 6.5 to φ 7.7 mm) | .283" to .315" (φ 7.2 to φ 8.0 mm) |
| HEAD THICKNESS | .039" to .059" (φ 1.0 to φ 1.5 mm) | .079" (φ 2.0 mm) |
| SHAPE OF THE POINT | DIAMOND POINT | BARISTIC POINT |

RECOMMENDED OPERATING PRESSURE:

210 to 320 p.s.i. (15 to 23 bar). Select the operating air pressure within this range for best fastener performance.
DO NOT EXCEED 320 p.s.i. (23 bar).

4. TECHNICAL DATA

① NOISE

A-weighted single-event — LWA, 1s, d 110.0 dB
sound power level

A-weighted single-event — LpA, 1s, d 97.5 dB
emission sound pressure
level at work station

These values are determined and documented in accordance to EN12549 : 1999.

② VIBRATION

Vibration characteristic value = 9.16 m/s²

These values are determined and documented in accordance to ISO 8662-11.

This value is a tool-related characteristic value and does not represent the influence to the hand-arm-system when using the tool.

An influence to the hand-arm-system when using the tool will for example depend on the gripping force, the contact pressure force, the working direction, the adjustment of mains supply, the workpiece, the workpiece support.

5. APPLICATIONS

- * Securing a thin steel plate to the concrete
- * Securing a wooden material to the concrete
- * Securing a wooden material to a thick steel plate

WARNING:

3. AIR SUPPLY AND CONNECTIONS

Read section titled "SAFETY INSTRUCTIONS".



DO NOT USE ANY POWER SOURCE EXCEPT AN AIR COMPRESSOR

The tool is designed to operate on compressed air. Do not operate the tool on any other highpressure gas, combustible gases (e.g., oxygen, acetylene, etc.) since there is the danger of an explosion. For this reason, absolutely do not use anything other than an air compressor to operate the tool.



OPERATE WITHIN THE PROPER AIR PRESSURE RANGE

The tool is designed to operate within an air pressure range of 210 to 320 p.s.i. (15 to 23 bar.)

The pressure should be adjusted to the type of the work being fastened. The tool shall never be operated when the operating pressure exceeds 320 p.s.i. (23 bar.)



DO NOT OPERATE THE TOOL NEAR A FLAMMABLE SUBSTANCE

Never operate the tool near a flammable substance (e.g., thinner, gasoline, etc.). Volatile fumes from these substances could be drawn into the compressor and compressed together with the air and this could result in an explosion.

DO NOT USE A WRONG FITTINGS

The connector on the tool must not hold pressure when air supply is disconnected. If a wrong fitting is used, the tool can remain charged with air after disconnecting and thus will be able to drive a fastener even after the air line is disconnected, possibly causing injury.



DISCONNECT THE AIR SUPPLY AND EMPTY THE MAGAZINE WHEN THE TOOL IS NOT IN USE

Always disconnect the air supply from the tool and empty the magazine when operation has been completed or suspended, when unattended, moving to a different work area, adjusting, disassembling, or repairing the tool, and when clearing a jammed fastener.

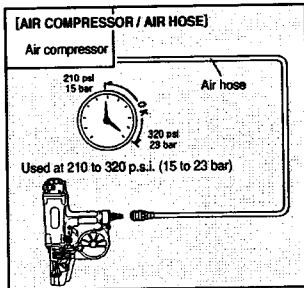

WHEN USING THE TOOL, BE SURE TO USE A SPECIAL AIR COMPRESSOR AND AIR HOSE.

In order to improve its performance, it has set its working pressure higher than the conventional nailers. To use the tool, you always need the special air compressor and air hose (MAX PowerLite Compressor and MAX PowerLite Hose). Use of high-pressure gas (for example, oxygen, acetylene, etc.) causes abnormal combustion, possibly resulting in explosion. Use only the special air compressor and air hose.

NOTE:

Frequent, but not excessive, lubrication is required for the best performance. Oil added thru the air line connection will lubricate the internal parts.

4. INSTRUCTIONS FOR OPERATION

Read section titled "SAFETY INSTRUCTIONS".

1. BEFORE OPERATION

- ① Wear Safety Glasses or Goggles.
- ② Do not connect the air supply.
- ③ Inspect screw tightness.
- ④ Check operation of the contact arm & trigger if moving smoothly.
- ⑤ Connect the air supply.
- ⑥ Check the air-leakage. (The Tool must not have the air-leakage.)
- ⑦ Hold the Tool with finger-off the trigger, then push the contact arm against the work-piece. (The tool must not operate.)
- ⑧ Hold the Tool with contact arm free from work-piece and pull the trigger. (The Tool must not operate.)
- ⑨ Disconnect the air supply.

▲ WARNING:

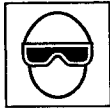

2. OPERATION

Wear safety glasses or goggles danger to the eyes always exists due to the possibility of dust being blown up by the exhausted air or of a fastener flying up due to the improper handling of the tool. For these reasons, safety glasses or goggles shall always be worn when operating the tool.

The employer and/or user must ensure that proper eye protection is worn. Eye protection equipment must conform to the requirements of the American National Standards Institute, ANSI Z87.1 (Council Directive 89/686/EEC of 21 DEC. 1989) and provide both frontal and side protection.

The employer is responsible to enforce the use of eye protection equipment by the tool operator and all other personnel in the work area.

NOTE: Non-side shielded spectacles and face shields alone do not provide adequate protection.

▲ WARNING:



Keep hands and body away from the discharge outlet when driving the fasteners because of dangerous of hitting the hands or body by mistake.

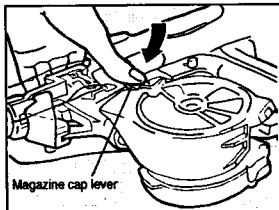

NAIL LOADING

- ① Lock the trigger and disconnect the air hose.
- ② Adjust the magazine direction in tune with the length of pins (or nails) used. First, push the magazine cap lever to open the magazine cap.

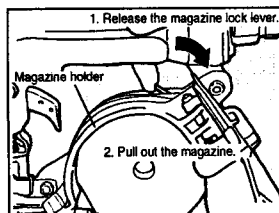

③ Check adjustment:

Release the magazine lock lever to detach the magazine from the magazine hook, and remove the magazine from the magazine holder.

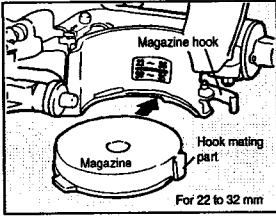

- ④ Determine the magazine direction in tune with the length of pins (or nails) used, fit the magazine collar into the groove in the magazine holder, set the magazine hook onto its mating part, and push the magazine lock lever to secure the magazine.

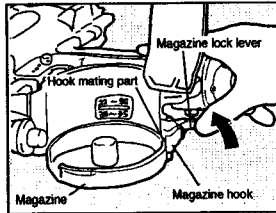
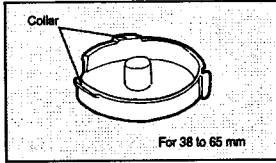

⚠ CAUTION:

- At shipment, the magazine has been set in the direction for the pin/nail length of 22 to 32 mm. When using 38 mm or longer pins/nails, set the magazine reversely.
- Be sure to set the magazine direction in tune with the length of pins (or nails) used. If used in the inadequate direction, the pins (or nails) are not fed properly.

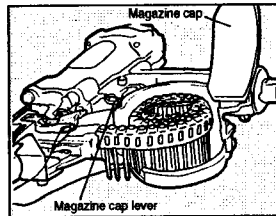

- ⑤ Push the magazine cap lever. With the magazine cap opened, set the pins (or nails) and pull out the front end of the pin (or nail) coil.

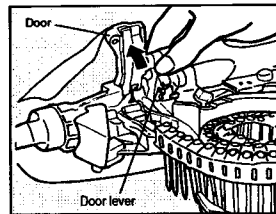

- ⑥ Push the door lever to open the door.

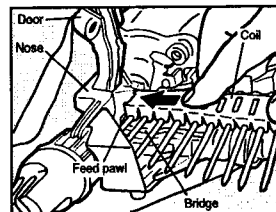

- ⑦ Push in the pin (or nail) coil along the bridge until it has reached the end. Pushing it in causes a feed pawl to swing away in between the first and second pins (or nails). Stop pushing it there.

⚠ CAUTION:

- Confirm that the first pin (or nail) has been entirely set before the feed pawl (into the nose).

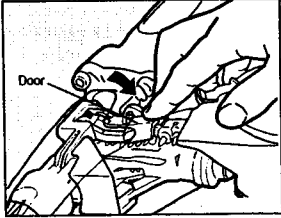

⑧ Push the door to close it.

▲ CAUTION:

Push the door firmly until the door lever has clicked.

⑨ Close the magazine cap.

⑩ Connect the air chuck to the air plug. You are now ready to drive the pins (or nails).

MODEL IDENTIFICATION

SEQUENTIAL TRIP

The Sequential Trip requires the operator to hold the tool against the work before pulling the trigger. This makes accurate fastener placement easier, for instance on framing, toe nailing and crating applications. The Sequential Trip allows exact fastener location without the possibility of driving a second fastener on recoil, as described under "Contact Trip".

The Sequential Trip Tool has a positive safety advantage because it will not accidentally drive a fastener if the tool is contacted against the work-or anything else-while the operator is holding the trigger pulled.

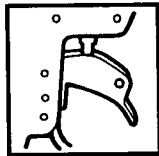

SEQUENTIAL TRIP

Identified by **ORANGE TRIGGER**.

SINGLE FIRE OPERATION (SEQUENTIAL TRIP)

For single fire operation, depress the contact arm against the work surface and pull the trigger. Tool can not fire a second nail until the trigger is released and tool can cycle.

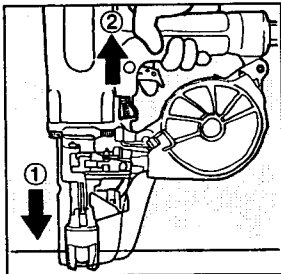

PROCEDURE

- ① Depress the contact arm.
- ② Pull the trigger.

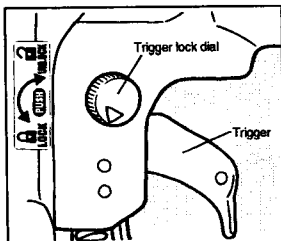

TRIGGER LOCK MECHANISM

The tool is equipped with a trigger lock mechanism. Push and rotate the trigger **LOCK** to the trigger **UNLOCK** position before driving nails.

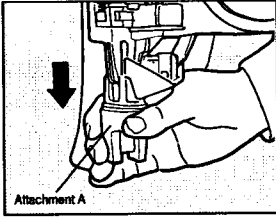

REPLACING THE ATTACHMENT

The machine comes with the attachments B and C as accessories. See the following for the replacement method.

⚠ WARNING:

When replacing the attachment, be sure to lock a trigger and remove an air hose.

PROCEDURE

① Remove the attachment A which has been attached at shipment; hold and draw it out with your hand, while holding it.

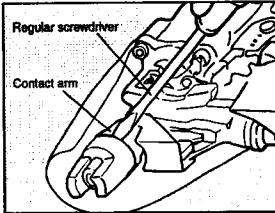

※ If it is not smoothly drawn out, insert a regular screwdriver, etc. into the clearance between a contact arm and it, and squeeze it to remove.

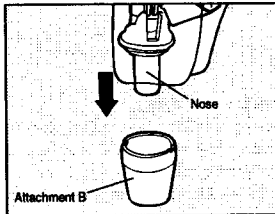

② Put down the attachment B or C, insert the nose of the machine, and push it against to attach.

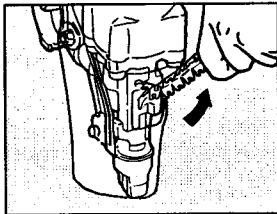

HOW TO REMOVE PLASTIC SHEET

As nails are driven the plastic sheet will feed out of the tool. When sufficient strip has been fed out it can be torn away by pulling against the tear edge in the nose.

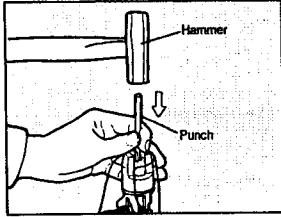

HOW TO REMOVE JAMMING OF PINS/NAILS

⚠ WARNING:

When removing jamming of pins (or nails), be sure to lock the trigger prior to disconnecting the air hose.

PROCEDURE

- ① Lock the trigger and disconnect the air hose.
- ② Remove the pins (or nails) out of the magazine.
- ③ Open the door, put a punch through the ejection port and hit it with a hammer.
- ④ Remove the pins (or nails) jamming inside the nose, using the punch or a regular screwdriver.
- ⑤ Set the pins (or nails) properly onto the feed pawl again and close the door.

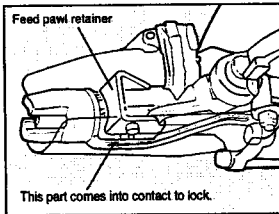
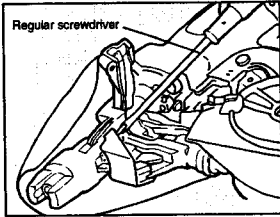

TROUBLESHOOTING

● The Machine is not activated even if it is operated correctly.

When the pins (or nails) are not fed properly, a locking mechanism works to deactivate the Machine. (Unless the feed pawl is completely OUT, it comes into contact with a feed pawl retainer, disabling pin/nail driving work.)

If the feed pawl is not located appropriately, remove the pins (or nails) and set them again.

● No pin (or nail) is driven even if the Machine is operated correctly.

If the Machine is activated, but no pin (or nail) is actually driven, check the following:

- ① Check whether or not the pins (or nails) have been set properly onto the feed pawl.
- ② Check whether or not the pins (or nails) have come off the Plasticsheet.
 - ※ If this is the case, cut off the empty Plasticsheet and set the pins (or nails) again.
- ③ Check whether or not the feed pawl and feed piston are being activated.
 - ※ If not activated, apply 5 to 6 oil drips from the air plug.

APPLICATIONS AND PINS/NAILS SELECTION CRITERIA

The Machine is applicable to the following purposes. When using it, select the pins/nails and leg length suitable for the driving object.

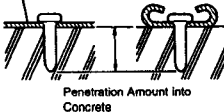
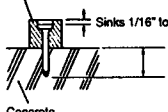
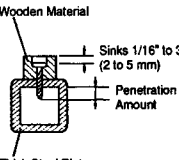
| Application | Type | Size (Leg Length) | Attachment Used | | | | | | | | | | | | |
|---|--------------------------------------|--|---|----------------------|----------------------------------|---------------|---------------|------------------------------------|----------------|---------------|------------------------------------|---------------|---------------|------------------------------------|---|
| Securing a thin steel plate to the concrete Ex.: Securing partition tracks | Plastic Coil Pins | Thin Steel Plate  Penetration Amount into Concrete Select the pins so that a penetration amount into the concrete will be 7/8" to 1" (20 to 25mm). | Attachment-A, Attachment-C CAUTION: Use of nails to secure the thin steel plate to the concrete causes them to recoil or bend, endangering you. Be sure to use pins to secure it to the concrete. | | | | | | | | | | | | |
| Securing a wooden material to the concrete Ex.: Securing drum edges | Plastic Coil Nails | Wooden Material  Sinks 1/16" to 3/16" (2 to 5 mm) Penetration Amount into Concrete Concrete Reference <table border="1" data-bbox="392 662 817 766"> <thead> <tr> <th>Wooden Material Thickness</th> <th>Nail Length Selected</th> <th>Penetration Amount into Concrete</th> </tr> </thead> <tbody> <tr> <td>1-1/8" (27mm)</td> <td>1-1/2" (38mm)</td> <td>Approx. 1/2" to 5/8" (13 to 16 mm)</td> </tr> <tr> <td>1-3/16" (30mm)</td> <td>1-3/4" (45mm)</td> <td>Approx. 5/8" to 7/8" (17 to 20 mm)</td> </tr> <tr> <td>1-3/4" (45mm)</td> <td>2-3/8" (60mm)</td> <td>Approx. 5/8" to 7/8" (17 to 20 mm)</td> </tr> </tbody> </table> | Wooden Material Thickness | Nail Length Selected | Penetration Amount into Concrete | 1-1/8" (27mm) | 1-1/2" (38mm) | Approx. 1/2" to 5/8" (13 to 16 mm) | 1-3/16" (30mm) | 1-3/4" (45mm) | Approx. 5/8" to 7/8" (17 to 20 mm) | 1-3/4" (45mm) | 2-3/8" (60mm) | Approx. 5/8" to 7/8" (17 to 20 mm) | Attachment-B CAUTION: Use of the attachment-A causes a nail sticking out to the wooden material. |
| Wooden Material Thickness | Nail Length Selected | Penetration Amount into Concrete | | | | | | | | | | | | | |
| 1-1/8" (27mm) | 1-1/2" (38mm) | Approx. 1/2" to 5/8" (13 to 16 mm) | | | | | | | | | | | | | |
| 1-3/16" (30mm) | 1-3/4" (45mm) | Approx. 5/8" to 7/8" (17 to 20 mm) | | | | | | | | | | | | | |
| 1-3/4" (45mm) | 2-3/8" (60mm) | Approx. 5/8" to 7/8" (17 to 20 mm) | | | | | | | | | | | | | |
| Securing a wooden material to a thick steel plate CAUTION: When using, allow for the nature of the driving object and the conditions at the work site to comply with the Work Standards. | Plastic Coil Nails (For Steel Plate) | Wooden Material  Sinks 1/16" to 3/16" (2 to 5 mm) Penetration Amount Thick Steel Plate Select the nails so that a penetration amount into the thick steel plate will be 3/8" (10 mm) or more. | Attachment-B CAUTION: Use of the attachment-A causes a nail sticking out to the wooden material. | | | | | | | | | | | | |